

OLIVER SOUND COMPANY INC.
WESTBURY, NEW YORK

WIRING DIAGRAM

DR BY	PT	7-1-70	MODEL
CHK BY	SB	7-1-70	PA100XR
APP BY	BT	7-1-70	

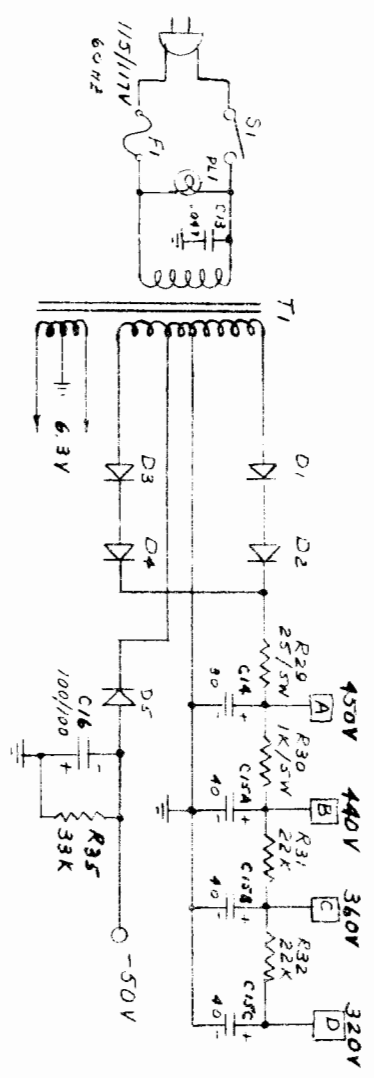
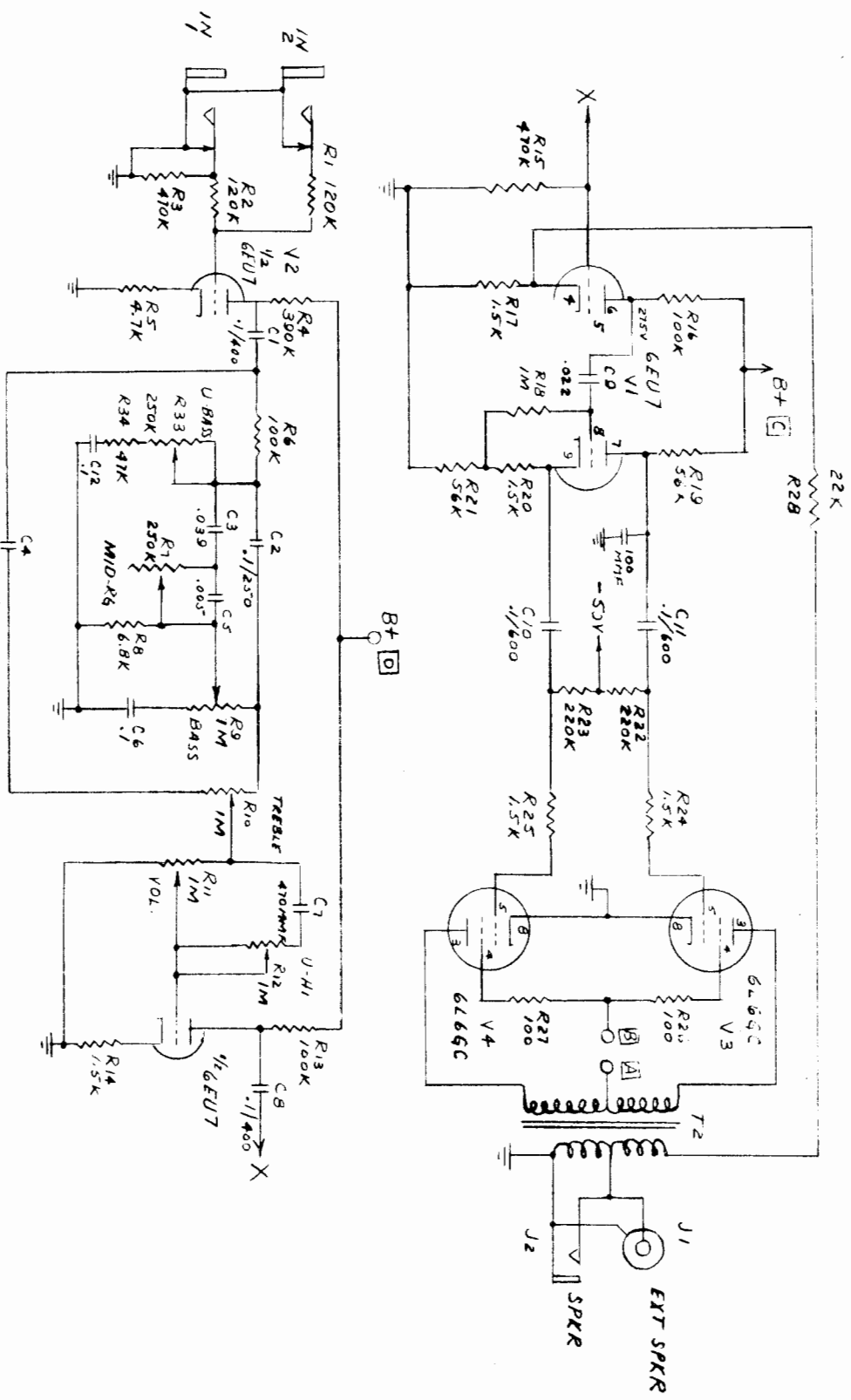

ALL RESISTORS $\frac{1}{2}$ WT
UNLESS OTHERWISE SPECIFIED

OLIVER SOUND COMPANY INC.
WESTBURY, N. Y.

WIRING DIAGRAM

DR	DATE
CHK <i>R</i>	DATE 2-70
APP O.J.	DATE 2-70
B-120	

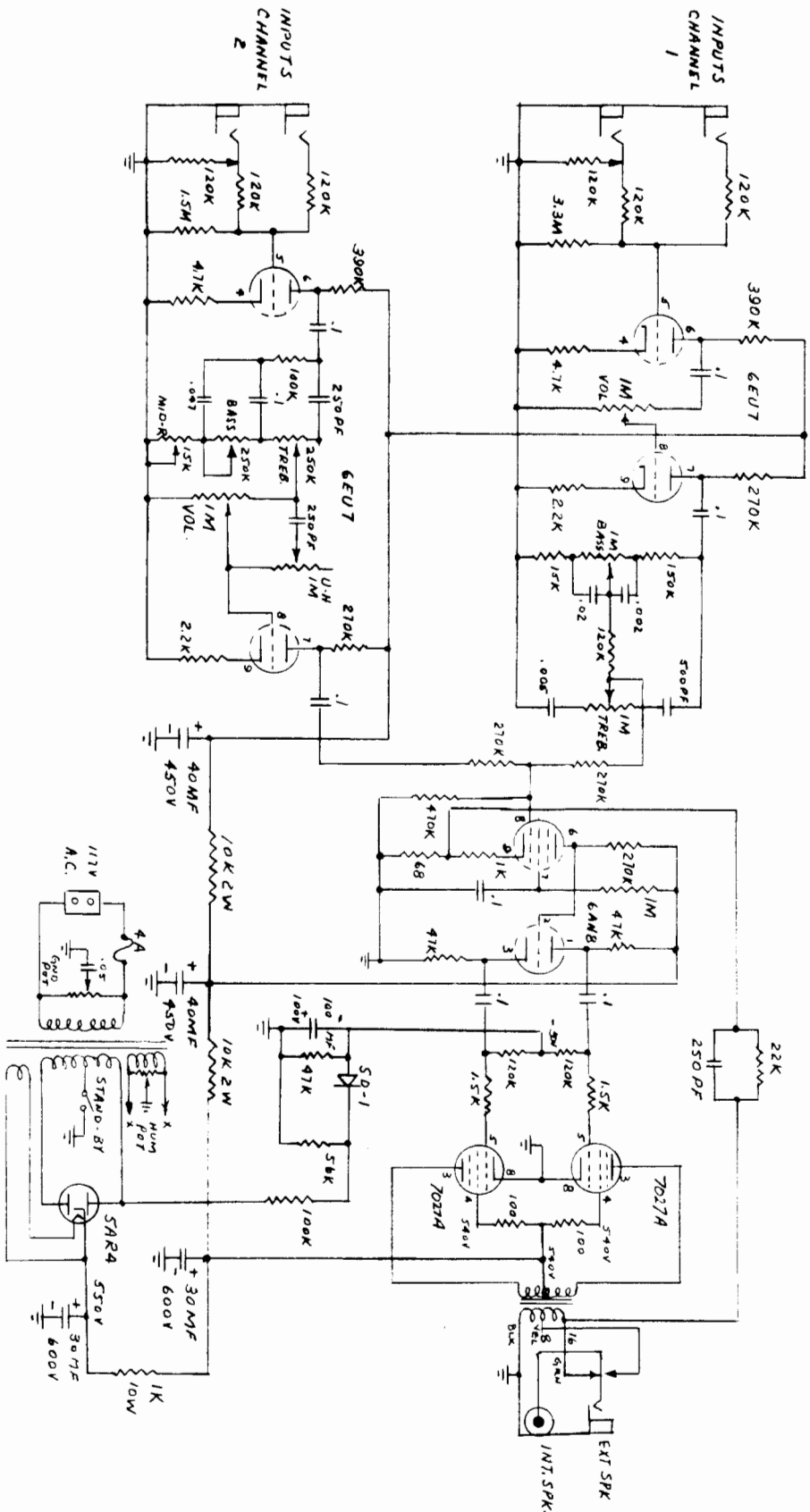

OLIVER SOUND COMPANY INC.
 WESTBURY, NEW YORK

WIRING DIAGRAM

DR. BY	RT	7-17-70	
CHK. BY	SR	7-17-70	
...	BT	7-17-70	ASD/EF

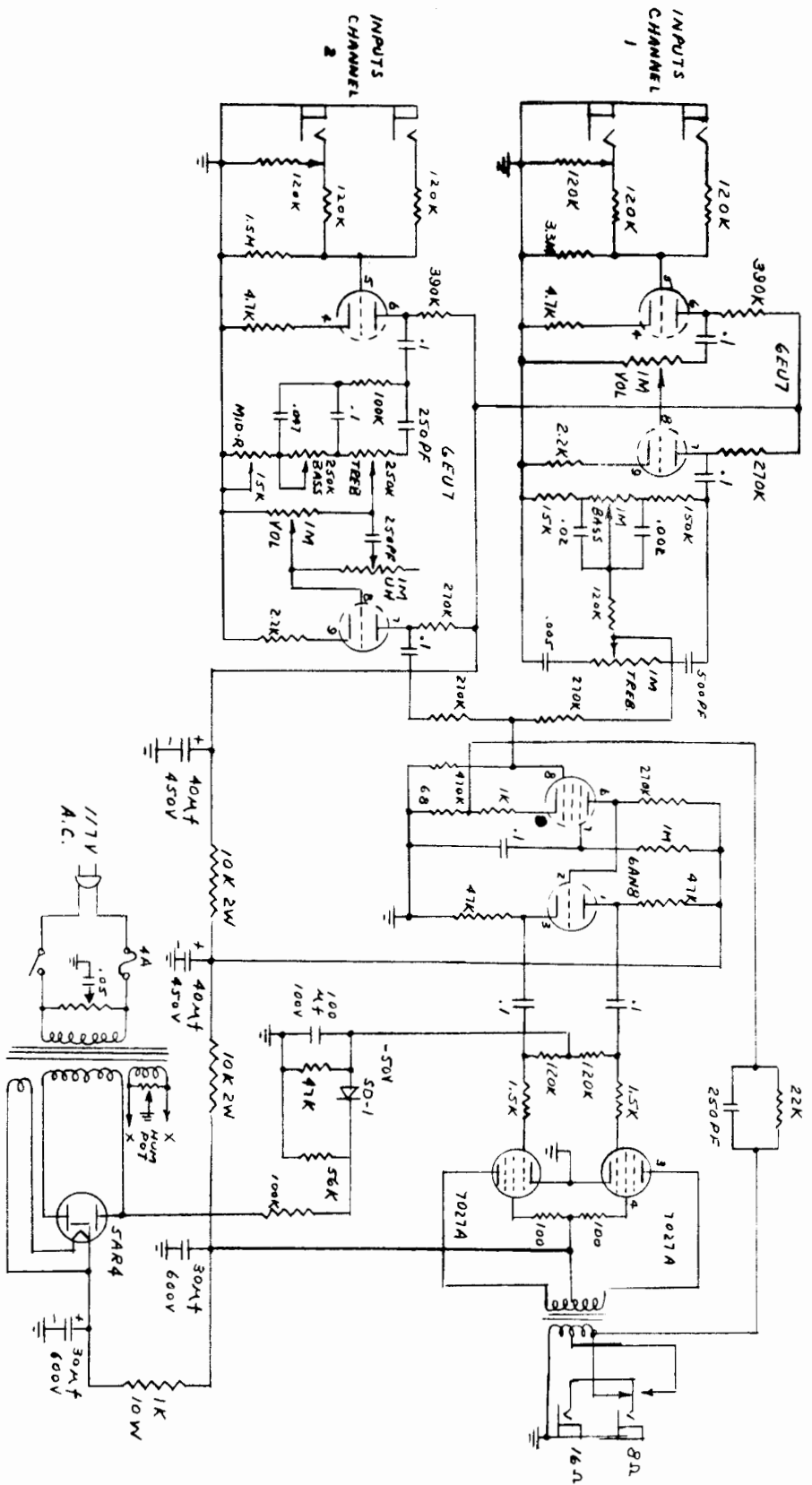

OLIVER SOUND COMPANY INC.
 WESTBURY, NEW YORK

WIRING DIAGRAM

DATE	RT	7-17-70	
BY	SP	7-17-70	
REV	67	7-17-70	PA-100X

LIST PRICE SCHEDULE

Effective: July 15, 1972



POWER AMPLIFIER HEADS

H-100.....	3 Controls, 3 Inputs, 90 watts PMP (35 RMS)	\$160.00
H-100R.....	as above, with Reverb and 4 Controls	225.00
PA-100X.....	Multiple Controls, 2 Channels, 4 Inputs, 156 watts PMP (60 RMS)	240.00
PA-100XR.....	as above, with Reverb	330.00
PA-150XR.....	as above, with 4 Channels, 8 Inputs, extra features	400.00
PA-200XR.....	as above, 240 watts PMP (92 RMS)	600.00



BASS AMPS

B-100.....	3 Controls, 3 Inputs, 90 watts PMP (35 RMS), 15" Speaker, 1-pc. Unit	240.00
B-120.....	Multiple Controls, 90 watts PMP (35 RMS), Heavy-Duty 15" Speaker, 1-pc. Unit	290.00
B-150.....	Multiple Controls, 2 Channels, 4 Inputs, 156 watts PMP (60 RMS), Heavy Duty 15" Speaker, 2-pc. Unit	425.00
B-200.....	as above, with Two (2) Heavy-Duty 15" Speakers	535.00
B-212.....	Multiple Controls, 90 watts PMP (35 RMS), Two (2) Heavy-Duty 12" Speakers, 1-pc. Unit	370.00
B-240.....	Multiple Controls, 2 Channels, 4 Inputs, 240 watts PMP (92 RMS), Two (2) Heavy-Duty 15" Speakers, 2-pc. Unit	800.00



GUITAR AMPS—ALL WITH REVERB

G-150R.....	Multiple Controls, 2 Channels, 4 Inputs, 90 watts PMP (35 RMS), 15" Speaker, 1-pc. Unit	355.00
G-200R.....	as above, with Two (2) Heavy-Duty 12" Speakers	440.00
G-400R.....	Multiple Controls, 2 Channels, 4 Inputs, 156 watts PMP (60 RMS), Two (2) Heavy-Duty 15" Speakers, 2-pc. Unit	600.00
G-2400R.....	as above, with Two (2) Heavy-Duty 12" Speakers, 1-pc. Unit	500.00



COLUMNS

C-412.....	Four (4) Heavy-Duty 12" Speakers, Double Jack and Fuse (rear mounted), Heavy-Duty 54" Cabinet with 3 Handles	ea. 200.00
------------	--	------------



ORBITAL POWER PROJECTOR

OP-1.....	Rotating Horn with Infinite Speed Control	275.00
-----------	---	--------



ACCESSORIES

FS-280.....	Standard Single Foot Switch fits PA-100XR, PA-150XR, PA-200XR, H-100R and Horn Jack of OP-1	8.00
FS-290.....	Standard Double Foot Switch fits all models with Reverb and Tremolo	12.00
FS-480.....	Special Single Foot Switch (Mode Jack on OP-1 only).....	16.00
S-1.....	Fitzall Dolly (quick detach)	24.00
B-10.....	Cover (Head only) fits B-150, B-200, G-400R	8.00
B-19.....	Cover (Head only) fits H-100, H-100R, PA-100X, PA-100XR	8.00
B-24.....	Cover (Bottom only) fits B-150	13.00
B-32.....	Cover fits Amps B-100, B-120, G-150R	17.00
B-36.....	Cover fits Amps G-200R, B-212, G-2400R	17.00
B-37.....	Cover (Bottom only) fits B-200, G-400R	29.00

OLIVER SOUND COMPANY INC.
 MUSICAL INSTRUMENT & VOICE AMPLIFICATION SYSTEMS
 65 KINKEL ST. WESTBURY, N. Y. 11590 • 516 333 3770

operating and maintenance instructions

MODEL B-120
UNIFLEX BASSAMP

CONGRATULATIONS: You are now the owner of the finest amplifier made. It has been designed and handcrafted to give you many years of high quality, trouble free performance.

Please read and return the warranty card for validation of your warranty.

Read the operating instructions.

Talk to your authorized OLIVER dealer. His knowledge and experience can be helpful to you.

OPERATING INSTRUCTIONS:

POWER LINE CONNECTION: The power cord is stored in the amplifier chassis compartment. Connect the plug to any convenient outlet 105/117 volt 50/60 cycle.

POWER SWITCH: Move toggle switch to the on position and allow a few moments for warm up. Pilot light will indicate that power is on.

INPUT JACKS: Model B-120 has two, isolated input jacks. Plug instrument into one. The unused jack can be used as an auxiliary for another instrument if needed.

VOLUME CONTROL: Turn clockwise to increase volume of sound.

STONE CONTROLS: These controls are specialized volume controls which enable you to set the response of the high range, mid range, and low range in any combination.

THE FOLLOWING PROCEDURE IS RECOMMENDED IN SETTING UP YOUR AMPLIFIER.

Turn volume and tone controls of your instrument (not the amplifier) at maximum output. These may be readjusted after your amplifier controls are set. Set the amplifier volume control at half way point. Set the amplifier bass, mid-range and treble controls at the half way point. Set the ultra-high and ultra-bass controls at the extreme counter clockwise position. For a brighter sound increase the treble control. If you reach maximum and still wish more brightness increase the Ultra-High control. For more bass increase the bass control. If you reach maximum and still wish more bass increase the Ultra-Bass control.

Experimentation will help you determine the final settings of the amplifier to give you the sound you want.

The Mid-Range control causes the greatest change in effective volume and adds more punch to the output of most instruments.

CARE AND MAINTENANCE

Your OLIVER amplifier is engineered and built to exacting standards. Should your amplifier require service, we suggest you check with your authorized OLIVER dealer for the address of the nearest OLIVER service center.

Sometimes line disturbances may cause an objectionable hum. To eliminate this simply reverse the power cord plug in the outlet.

FUSE: REPLACE FUSE WITH 3 AMP FUSE ONLY.

The case covering may be cleaned with any mild soap, detergent or vinyl cleaner. A lustrous finish may be added by using any available vinyl wax.



operating and
maintenance instructions

UNIFLEX GUITAR AMP

MODEL G-150R
MODEL G-200R

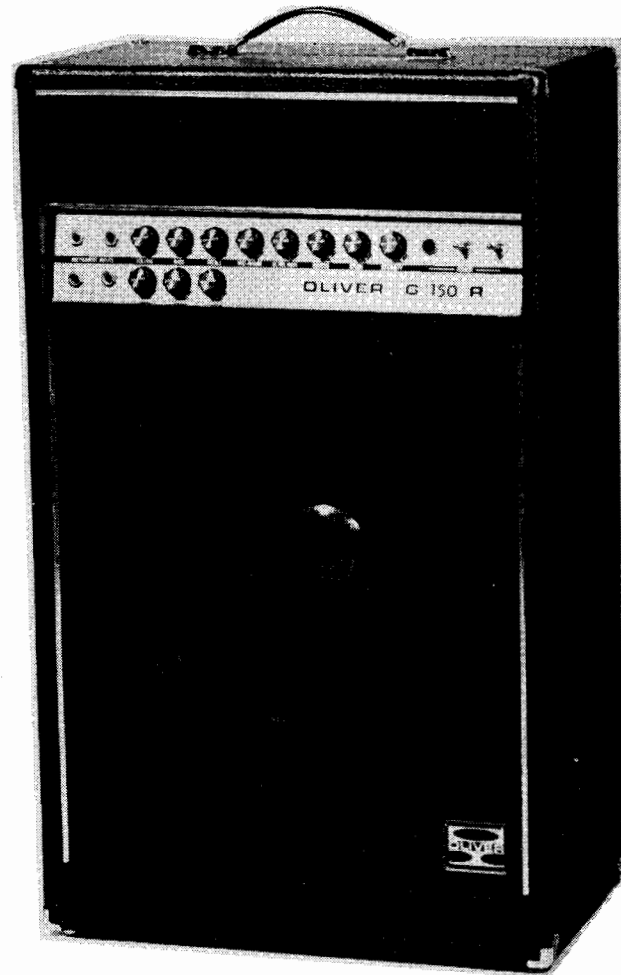

CONGRATULATIONS: You are now the owner of the finest amplifier made. It has been designed and handcrafted to give you many years of high quality, trouble free performance.

Please read and return the warranty card for validation of your warranty.

Read the operating instructions.

Talk to your authorized OLIVER dealer. His knowledge and experience can be helpful to you.

OPERATING INSTRUCTIONS:

POWER LINE CONNECTION: The power cord is stored in the amplifier chassis compartment. Connect the plug to any convenient outlet 105/117 volts 50/60 cycle. (Export models use proper line voltage as indicated)

POWER SWITCH: Move toggle switch to the on position and allow a few moments for warm up. Pilot light will indicate that power is on.

ANTI-HUM: Sometimes line disturbances may cause an objectionable hum. To eliminate this, simply flip the Anti-Hum switch.

CHANNELS: This model has two channels. Channel one incorporates additional effects, tremolo and reverberation, and channel two is the "straight" channel. Select desired channel.

INPUT JACKS: Each channel has two isolated input jacks. Plug instrument into one. The unused jack can be used as an auxiliary for another instrument if needed.

VOLUME CONTROL: Turn clockwise to increase volume of sound.

STONE CONTROLS: These controls are specialized volume controls which enable you to set the response of the high range, mid range, and low range in any combination.

TREMOLO AND REVERB: If you wish to use these effects you must plug into channel one. For tremolo, set the speed and intensity controls to the desired level. For reverb, adjust the reverb control. For remote control of these effects, you may use a double foot switch with a standard two circuit phone plug. (Oliver Model PS 2 foot switch). The jack to accommodate this is located on the rear of the chassis.

THE FOLLOWING PROCEDURE IS RECOMMENDED IN SETTING UP YOUR AMPLIFIER.

Turn volume and tone controls of your instrument (not the amplifier) at maximum output. These may be readjusted after your amplifier controls are set. Set the amplifier volume control at half way point. Set the amplifier bass, mid-range and treble controls at the half way point. Set the ultra-high control at the extreme counter clockwise position. For a brighter sound increase the treble control. If you reach maximum and still wish more brightness increase the Ultra-high control if you are using channel one. Experimentation will help you determine the final settings of the amplifier to give you the sound you want.

CARE AND MAINTENANCE:

Your OLIVER amplifier is engineered and built to exacting standards; however, should your amplifier require service we suggest you check with your authorized OLIVER dealer for the address of the nearest OLIVER service center.

FUSE: REPLACE FUSE WITH 3 AMP FUSE ONLY.

The case covering may be cleaned with any mild soap, detergent or vinyl cleaner. A lustrous finish may be added by using any available vinyl wax.



OLIVER SOUND CO.
225 AVOCA AVE.
MASSAPEQUA PARK, N. Y. 11762

JESS OLIVER

Expert Electronic Service
Modifications, Tuning & Repairing
Organs • Pianos • Guitar Pickups
Amplifiers • Synthesizers • Etc.



OLIVER

**MUSICAL INSTRUMENT AMPLIFIERS
and VOICE AMPLIFICATION SYSTEMS**

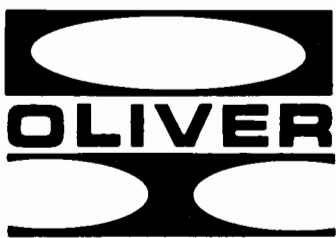

SOUND COMPANY INC.
65 KINKEL STREET, WESTBURY, N. Y. 11590
516/333-3770

Recommended for Bass, Organ or any instrument where Reverb and Tremolo are not required.

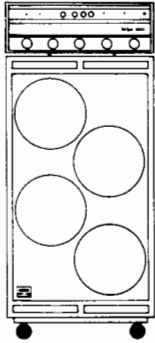
300W DUOFLEX

FEATURES: • 4 Oliver 15" Special Design Extra Heavy Duty Speakers • Single Channel, 2 Inputs • Individual volume, bass, mid-range, treble, ultra high and ultra bass controls • 360° turn detachable dolly • Piggy back type construction

OLIVER EXCLUSIVE FEATURES: • Stagger tuned speaker system for increased efficiency and low frequency power handling capacity.

Dimensions:
Head: 31" x 10" x 10" Weight: 75 lbs.
Speaker System: 56" x 31" x 15" Weight: 125 lbs.
PRICE.....\$1200.00
OPTIONS: Available with four JBL D140F speakers Specify Model L300W.....\$1650.00

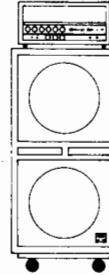
B200 DUOFLEX

FEATURES: • 2 Oliver 15" Special Design Extra Heavy Duty Speakers • Twin channels 4 inputs • Individual volume, bass, mid-range & treble controls for each channel. In addition, Channel 1 has an ultra high control, and Channel 2 an ultra bass control. • Piggy back type construction • Heavy Duty 360° turn detachable dolly.

Dimensions: Head: 9" x 19½" x 10". Wt.: 35 lbs.
Speaker System 44" x 22½" x 15" Weight 75 lbs.

PRICE.....\$499.00

OPTIONS:
Available with 2 Altec Lansing 15" Speakers. Specify Model B200A.....\$699.00
Available with additional matching speaker system containing 2 Oliver 15" Extra Heavy Duty, Special Design Speakers. Specify Model B200D.....\$749.00
With 4 Altec Lansing 15" Speakers in twin enclosures Specify Model B200DA.....\$1149.00

ACCESSORIES: Heavy Duty Black Vinyl Covers Head: \$5.00. Speaker Enclosure: \$24.00

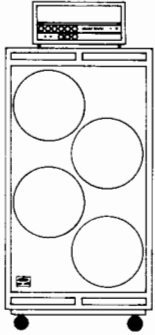
B600 DUOFLEX

FEATURES: • 4 - 15" Oliver Special Design Extra Heavy Duty Speakers • Twin Channels 4 Inputs • Individual volume, bass and treble controls for each channel. In addition, Channel 1 has ultra hi controls, and channel 2 has ultra bass controls. • Piggy-back type construction.

Dimensions: Head: 9" x 19½" x 10" Wt.: 35 lbs.
Speaker System: 56" x 31" x 15" Wt.: 115 lbs.

PRICE.....\$799.00

OPTIONS: Available with 4 Altec Lansing 15" Speakers. Specify Model B-600A.....\$1199.00

ACCESSORIES:
Heavy Duty Black Vinyl Covers Head.....\$ 5.00
Speaker Enclosures \$ 35.00

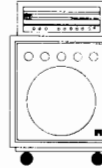
P500 POWERFLEX

FEATURES: 1 15" Oliver Special Design Extra Heavy Duty Speaker • Twin channels, 4 inputs • Individual volume, bass, & treble controls for each channel • Mid-range & ultra high controls (channel 2) • Heavy Duty 360° turn detachable dolly.

OLIVER EXCLUSIVE FEATURES: • Self-Elevating Power Head • Edge-Lit Control Panel • Self Retracting 15' Line Cord

Dimensions: 24" x 22½" x 14". Weight: 75 lbs.
PRICE.....\$525.00

OPTIONS: Available with 1 15" Altec Lansing Speaker. Specify Model P500A.....\$625.00
Available with additional matching speaker system containing 1 Oliver 15" Special Design Heavy Duty Speaker & 15' self-retracting connecting cord with standard phone plug. Specify Model P500D \$684.00
With 2 15" Altec Lansing Speakers in twin enclosures. Specify Model P500DA.....\$884.00
ACCESSORIES: Heavy Duty black vinyl cover \$ 15.00

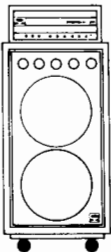
P500F POWERFLEX

FEATURES: 2 Oliver 15" Special Design Extra Heavy Duty Speakers • Twin channels 4 inputs • Individual volume, bass & treble controls for each channel. • Midrange & ultra high controls (channel 2) • Heavy Duty 360° turn detachable dolly assembly.

OLIVER EXCLUSIVE FEATURES: • Self-Elevating Power Head • Edge-Lit Control Panel • Self-Retracting 15' Line Cord

Dimensions: 41" x 22½" x 14. Weight 90 lbs.

PRICE.....\$625.00
OPTIONS: Available with 2 Altec Lansing 15" Speakers. Specify Model P500FA.....\$825.00

Available with additional matching speaker system containing 2 Oliver 15" Extra Heavy Duty Special Design Speakers & 15' self-retracting connecting cable with standard phone plug. Specify Model P500FD.....\$900.00

Available with 4 Altec Lansing 15" speakers in dual enclosures. Specify Model P500FDA.....\$1195.00

ACCESSORIES: H.D. black vinyl cover.....\$ 25.00

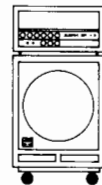
B150 DUOFLEX

FEATURES: 1 Oliver 15" Special Design Extra Heavy Duty Speaker • Twin channels, 4 inputs • Individual volume, bass, mid-range, treble controls for each channel. In addition, Channel 1 has ultra high control, Channel 2 has ultra bass control • Piggy back type construction • Heavy Duty 360° turn detachable dolly.

Dimensions: Head: 9" x 19½" x 10" Wt. 35 lbs.
Speaker System: 32" x 19" x 11½" Wt. 50 lbs.

PRICE.....\$399.00

OPTIONS: Available with 1 Altec Lansing 15" Speaker. Specify Model B150A.....\$520.00

ACCESSORIES:
Heavy Duty Black Vinyl covers, Head..... \$ 5.00
Speaker Enclosure.....\$ 10.00

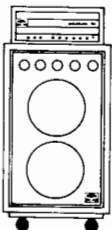
P500T POWERFLEX

FEATURES: 2 Oliver 12" Special Design Extra Heavy Duty Speakers • Twin Channels 4 inputs • Individual volume, bass & treble controls for each channel • Mid-Range & ultra high controls (Channel 2) • Heavy Duty 360° turn detachable dolly assembly.

OLIVER EXCLUSIVE FEATURES: Self-Elevating Power Head • Edge-lit control panel • Self-retracting 15' line cord.

Dimensions: 36" x 22½" x 14". Weight: 80 lbs.

PRICE.....\$570.00

OPTIONS: Available with additional matching speaker system containing 2 Oliver 12" Extra Heavy Duty Special Design Speakers & 15' self-retracting connecting cable with standard phone plug. Model P500TD \$784.00

ACCESSORIES:
Heavy Duty black vinyl cover.....\$ 25.00

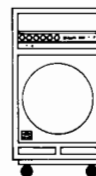
B120 UNIFLEX

FEATURES: • 1 Oliver 15" Special Design Heavy Duty Speaker • Single Channel, 2 inputs • Individual volume, bass, midrange, treble, ultra high & ultra bass controls • Unitized cabinet type construction.

Dimensions: 32" x 19" x 11½". Weight: 53 lbs.

PRICE.....\$269.00

OPTIONS: Available with 1 Altec Lansing 15" speaker. Specify Model B120A.....\$389.00

ACCESSORIES:
Heavy Duty black vinyl cover.....\$ 13.00
Heavy Duty 360° turn detachable dolly.....\$ 17.00

Recommended for Guitar or any instrument where Reverb and Tremolo are required.

**P502FA
POWERFLEX**

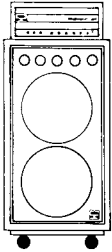

FEATURES: 2 Altec Lansing 15" Speakers • Twin Channels, 4 Inputs • Individual Volume, Bass, & Treble Controls for each channel • Reverb, Tremolo, Speed & int. Mid-range & Ultra High Controls (Channel Two) • Heavy Duty 360° turn detachable dolly assembly.

OLIVER EXCLUSIVE FEATURES: • Self-Elevating Power Head • Edge-Lit Control Panel • Self-Retracting 15' Line Cord

Dimensions: 41" x 22½" x 14". Weight 97 lbs.

PRICE:..... \$934.00

OPTIONS: • Available with additional matching speaker system containing 2 Altec Lansing 15" Speakers & 15' Self-Retracting connecting cable with standard phone plug. Specify Model P502FDA

PRICE:..... \$1310.00

ACCESSORIES:

Heavy Duty black vinyl cover B5F..... \$ 25.00

**G200R
UNIFLEX**

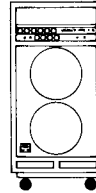

FEATURES: 2 Oliver 12" Special Design Heavy Duty Speakers • Twin channels, 4 inputs • Individual Volume, Bass, & Treble Controls for each channel • Reverb, Tremolo, Mid-range, & Ultra High Controls (Channel One) • Unitized cabinet construction.

Dimensions: 36" x 19" x 11½". Weight: 65 lbs.

PRICE:..... \$439.00

OPTIONS: Available with 2 Altec Lansing 12" Speakers. Specify Model G-200RA..... \$619.00

ACCESSORIES:

Heavy Duty black vinyl cover..... \$ 13.00

Heavy Duty 360° turn detachable dolly \$ 17.00

**P502A
POWERFLEX**

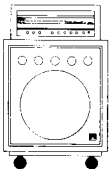

FEATURES: • 1 Altec Lansing 15" Speaker • Twin Channels 4 Inputs • Individual Volume, Bass, & Treble Controls for each channel. • Reverb, Tremolo, speed & int. Mid-Range and Ultra High Controls (Channel Two) • Heavy Duty 360° Turn Detachable Dolly Assembly.

OLIVER EXCLUSIVE FEATURES: • Self-Elevating Power Head • Edge-Lit Control Panel • Self Retracting 15' Line Cord.

Dimensions: 24" H x 22½" W x 14"

Weight: 80 lbs. PRICE \$724.00

OPTIONS: • Available with additional matching speaker system containing 1 Altec Lansing 15" Speaker & 15' Self-Retracting Connecting Cable with standard phone plug.

Specify Model P502DA..... \$995.00

ACCESSORIES

• Heavy Duty Black Vinyl Cover B5.....\$ 15.00

**G150R
UNIFLEX**

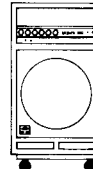

FEATURES: • 1 Oliver 15" Special Design Heavy Duty Speaker • Twin channels 4 inputs • Individual volume, bass & treble controls for each channel • Reverb, tremolo, mid-range & ultra high controls (channel one) • Unitized cabinet construction

Dimensions: 32" x 19" x 11½" Weight: 55 lbs.

PRICE:..... \$329.00

OPTIONS: Available with one Altec Lansing 15" speaker. Specify Model G150RA..... \$439.00

ACCESSORIES:

Heavy Duty black vinyl cover.....\$ 13.00

Heavy Duty 360° turn detachable dolly....\$ 17.00

**G400R
DUOFLEX**

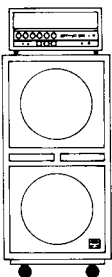

FEATURES: • 2 Oliver 15" Special Design Extra Heavy Duty Speakers • Twin channels, 4 inputs • Individual Volume, Bass, & Treble Controls for each channel • Reverb, Tremolo, Speed & Int. Mid-range & Ultra High Controls (Channel One). • Piggy-Back type construction • Heavy Duty 360° turn detachable dolly

Dimensions: Head: 9" x 19½" x 10". Speaker System: 44" x 22½" x 15". Weight: Head 35 Lbs. Speaker System: 75 lbs.

PRICE:..... \$569.00

OPTIONS: Available with 2 Altec Lansing 15" Speakers. Specify Model G400RA..... \$769.00

Additional matching speaker system containing 2 Oliver 15" Extra heavy duty special design speakers. Specify Model G600RD..... \$820.00

With 4 Altec Lansing 15" Speakers in twin enclosures Specify Model G400RDA..... \$1220.00

ACCESSORIES: Heavy Duty black vinyl covers. Head: \$5.00. Speaker Enclosure: \$24.00

**G120R
LITTLE
DAVID**

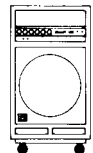

FEATURES: 1 Oliver 12" Special Design, Heavy Duty Speaker • Single channel 2 inputs • Individual volume, bass, mid-range, treble, reverb, tremolo speed and depth controls.

Dimensions: 28" x 19" x 11½" Weight: 45 lbs.

PRICE:..... \$239.50

OPTIONS: Available with one 12" Altec Lansing speaker. Specify Model G120RA.....\$359.50

ACCESSORIES:

Heavy Duty black vinyl cover..... \$ 10.00

Heavy Duty 350° turn, detachable dolly. \$ 17.00

OLIVER SOUND warrants its products for the lifetime of the original purchaser against defects in material and workmanship. This specifically excludes broken tubes, and loudspeakers with torn or ruptured diaphragms. The obligations of OLIVER SOUND under this warranty are limited to the replacement of material required to replace or repair any part, which under normal usage and service, upon examination by OLIVER SOUND shows evidence of defect. This warranty does not extend or apply to any unit which has been repaired or altered by persons not expressly approved by OLIVER SOUND, nor to any unit the serial number of which has been altered defaced or removed. This warranty is in lieu of all other warranties, expressed or implied, and no other representatives or persons are authorized to assume for OLIVER SOUND any other liability in connection with the sale or use of such products or parts thereof. The warranty extends only to the original consumer purchaser and is not assignable or transferable. OLIVER SOUND shall not be liable for any consequential damage or expense directly or indirectly arising from the use of the product or any inability to use it either separately or in combination with other equipment or product accessories. See warranty card.



**LIFETIME
GUARANTEE**

"I'm getting Revolutionary Vibrations
with my **OLIVER ELECTRO-VIBE PICK-UP***"

says **GARY BURTON** Atlantic Recording Star



New OLIVER ELECTRO-VIBE PICK-UP* with Volume Control and Standard Output Jack.

Available for most popular brand vibraphones. Specify make and model number, when ordering.

PRICE (All Models) \$450.00

Here's how...

- Projects vibraphone sound at any level without acoustic or magnetic feed-back
- Virtually transforms vibraphone into a new instrument, can be used with Fuzz, Wah-wah, Tremolo and Vibrato effects.
- May be used with or without resonator tubes
- Increases projection and versatility
- Does not affect instrument's acoustic properties, when played unamplified
- Unlimited volume performance with far less effort
- Use of lighter mallets with less force opens the way for improved articulation

*Patent Pending

SPECIAL VIBRAPHONE AMPLIFIERS

Customized especially for the Vibraphone. Similar to models G400R and G400RA, except single speaker versions. Detachable dolly included.

G300R Price \$499.00

Available with Altec Speaker

Accessories: Heavy Duty black vinyl covers.

G300RA Price \$620.00

Head: \$5.00. Speaker Enclosure: \$10.00

OLIVER PA-100 SERIES

The OLIVER PA 100X Series employs all of the circuitry of the POWERFLEX 500 Series and adapts this powerful amplifier for use with P.A. systems. It is highly recommended for driving the Oliver Sound Projector or any other quality sound system.

PA-100X

- Twin channels, 4 inputs
 - Individual Volume, Bass, Treble, Ultra High, and Mid-Range Controls
 - Ground Control for Polarity Reversal
 - Two Rear Located Speaker Jacks -- 8 & 16 ohm Impedance
 - Edge-Lit Control Panel
- Price \$ 225.00**

PA-100XR

- Twin channels, 4 inputs
 - Individual Volume, Bass, Treble, Ultra High, Mid-Range, and Reverb Controls
 - Ground Control for Polarity Reversal
 - Two Rear Located Speaker Jacks -- 8 & 16 ohm Impedance
 - Edge-Lit Control Panel
- Price \$ 310.00**

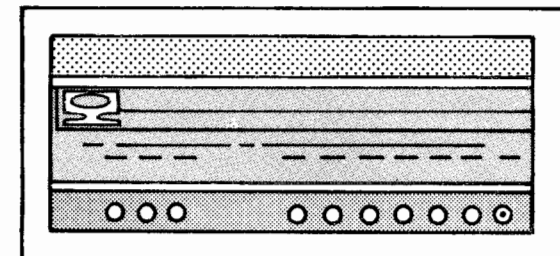

PA-100XRT

- Twin channels, 4 inputs
 - Individual Volume, Bass, Treble, Ultra High, Mid-Range, Reverb and Tremolo Controls
 - Ground Control for Polarity Reversal
 - Two Rear Located Speaker Jacks -- 8 & 16 ohm Impedance
 - Edge-Lit Control Panel
- Price \$ 345.00**

ACCESSORIES

- Heavy Duty Black Vinyl Cover B 19 \$ 7.00

Foot Switches:

- Single, for Remote Control of Reverb or PA-100XR FS-1 \$ 6.50
- Double, for all models equipped with Reverb & Tremolo FS-2 \$ 9.00

OLIVER SOUND CO., INC., 65 KINKEL STREET, WESTBURY, N. Y. 11590 516/333-3770

PRICES AND SPECIFICATIONS SUBJECT TO CHANGE WITHOUT NOTICE

EFFECTIVE DATE: JUNE 1970

F.O.B. WESTBURY, N.Y.

